

NVR301-E2 Series



Key Features

- Support Ultra 265/H.265/H.264 video formats
- 4/8/16-channel input
- Third-party IP cameras supported with ONVIF conformance: Profile S, Profile G, Profile T
- Support 1-ch HDMI, 1-ch VGA, HDMI at up to 4K(3840x2160) resolution
- HDMI and VGA simultaneous output
- Up to 4K resolution recording
- 1 SATA HDD up to 6TB
- Support cloud upgrade

Specifications

Model	NVR301-04E2	NVR301-08E2	NVR301-16E2
Video/Audio Input			
IP Video Input	4-ch	8-ch	16-ch
Two-way Audio Input	1-ch, RCA		
Network			
Incoming Bandwidth	64Mbps		
Outgoing Bandwidth	64Mbps		
Remote Users	128		
Protocols	P2P, UPnP, NTP, DHCP, PPPoE		
Video/Audio Output			
HDMI/VGA Output	HDMI: 3840x2160/30Hz, 1920x1080p/60Hz, 1920x1080p/50Hz, 1600x1200/60Hz, 1280x1024/60Hz, 1280x720/60Hz, 1024x768/60Hz VGA: 1920x1080p/60Hz, 1920x1080p/50Hz, 1600x1200/60Hz, 1280x1024/60Hz, 1280x720/60Hz, 1024x768/60Hz		
Recording Resolution	4K/5MP/4MP/3MP/1080p/960p/720p/D1/2CIF/CIF		

Synchronous Playback	4-ch	8-ch	16-ch
Corridor Mode Screen	3/4	3/4/5/7/9	3/4/5/7/9/10/12/16
Decoding			
Decoding format	Ultra 265/H.265/H.264		
Liveview/Playback	4K/5MP/4MP/3MP/1080p/960p/720p/D1/2CIF/CIF		
Capability	1 x 4K@30, 1 x 5MP@30, 2 x 4MP@30, 2 x 3MP@30, 4 x 1080p@30	1 x 4K@30, 1 x 5MP@30, 2 x 4MP@30, 2 x 3MP@30, 4x 1080p@30, 8 x 720p@30	1 x 4K@30, 1 x 5MP@30, 2 x 4MP@30, 2 x 3MP@30, 4x 1080p@30, 8 x 720p@30, 16 x D1@30
Hard Disk			
SATA	1 SATA interface		
Capacity	up to 6TB for each disk		
Smart			
VCA Detection	Face detection, Intrusion detection, Cross line detection, Audio detection, Defocus detection, Scene change detection, Auto tracking, Object Left Behind, Object Removed		
VCA Search	Face search, Behavior search		
Statistical Analysis	People counting		
External Interface			
Network Interface	1 RJ45 10M/100M self-adaptive Ethernet Interface		
USB Interface	Rear panel: 1 x USB2.0, 1 x USB3.0		
General			
Power Supply	12V DC Power Consumption: ≤9 W (without HDD)		
Working Environment	-10°C ~ + 55°C (+14°F ~ +131°F), Humidity ≤ 90% RH (non-condensing)		
Dimensions (W×D×H)	260mm × 240mm × 47mm (10.2"×9.4"×1.9 ")		
Weight (without HDD)	1.3kg (2.87 lb)		

Dimensions

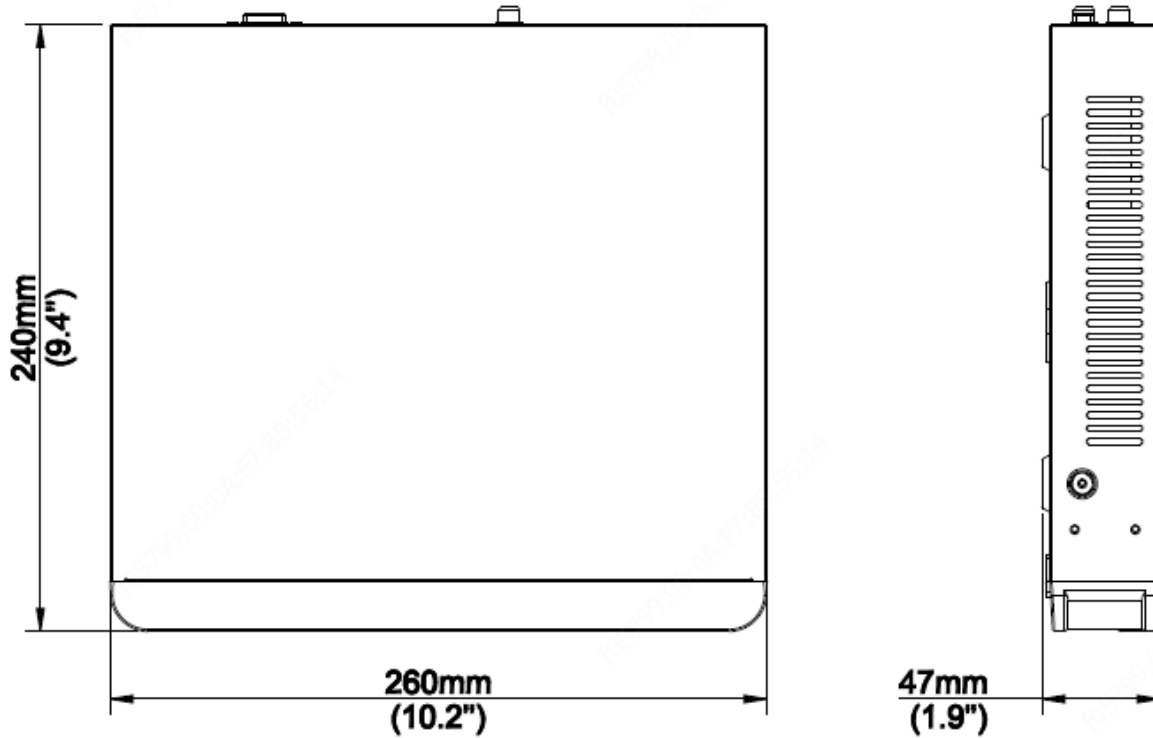

Rear Panel

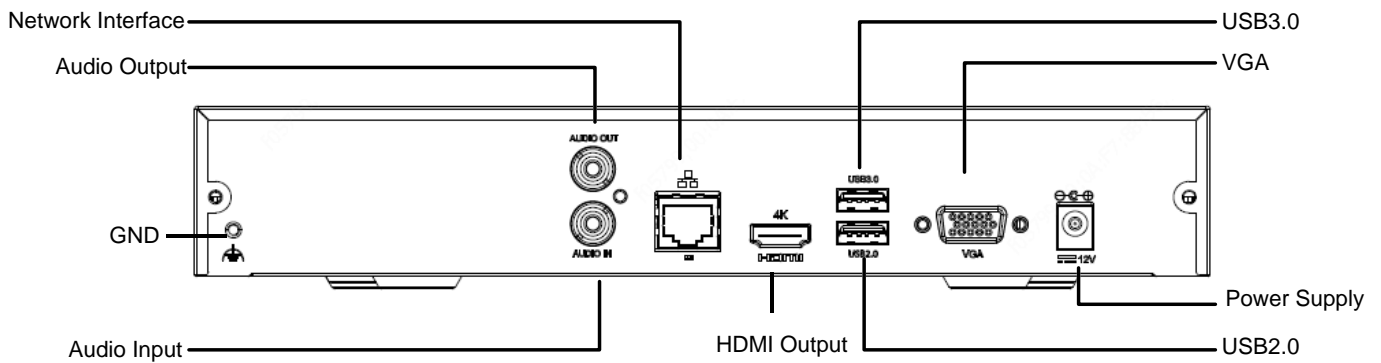

Zhejiang Uniview Technologies Co., Ltd.

Building No.10, Wanlun Science Park, Jiangling Road 88, Binjiang District, Hangzhou, Zhejiang, China

Email: overseasbusiness@uniview.com; globalsupport@uniview.com

<http://www.uniview.com>

©2019 Zhejiang Uniview Technologies Co., Ltd. All rights reserved.

* Product specifications and availability are subject to change without notice.